

neat

D-POS II Technical Handbook



D-POS II - Technical Handbook

Handbook for Technical Administrators - NE41 17030-02 v1.0

© Copyright 2018 NEAT Electronics
All rights reserved.
Document number: [NE41 17030-02 v1.0](#)
Revision date: 2018-04-04

Contact

[NEAT Electronics AB](#)
[Varuvägen 2](#)
[SE246 42 Löddeköpinge](#)
[Sweden](#)

Phone: [+46 46 70 70 65](#)
Fax: [+46 46 70 70 87](#)

www.neat-group.com/se/en
infosweden@neat-group.com

Content

1	Introduction	5
1.1	Intended use	5
1.2	General	5
1.3	This handbook	5
1.3.1	Declaration of conformity	5
2	Important	6
2.1	Safety notes	6
2.2	Use	6
2.3	Cleaning	6
2.4	Recycling	6
3	Parts in the system	7
3.1	D-POS II unit	7
3.2	D-POS Antenna	7
3.3	Loop Antenna	7
3.4	SMILE ID	7
3.5	D-TREX2G	7
3.6	DOOR	7
3.7	LOOP	7
3.8	U-DAT S	7
4	D-POS II hardware	8
4.1	Hardware overview	8
4.2	Connectors	8
4.2.1	Rotary switches (S1 - S3)	9
4.2.2	Potentiometer (P1)	9
4.2.3	DIP Switches (DIP1 - DIP8)	9
4.3	LED	10
4.3.1	LED indications and functions	10
4.4	Relay	10
4.5	Power supply	10
5	D-POS II configuration	11
5.1	Local programming	11
5.1.1	Setting position ID and Zone	11
5.1.2	Enter Radio Transmitters	11
5.1.3	RFID range adjustment	12
5.1.4	Tamper and malfunction	13
5.1.5	External input	13
5.1.6	Walk test	13
5.2	Programming with computer	14

6	WALL family programmer	15
6.1	Select device tab	15
6.2	RFID, I/O and General info tab	15
6.2.1	Local programming vs computer programming	16
6.2.2	RFID section	16
6.2.3	Relay	17
6.2.4	Tamper	17
6.2.5	EXT input	17
6.2.6	Read of switches	18
6.2.7	General info	18
6.3	Radio tab	18
6.3.1	Radio receiver	18
6.3.2	Radio transmitter	19
6.3.3	Alarm types	19
6.3.4	Plug-n-play	19
7	Portable trigger SMILE ID	20
7.1	Unit appearance	20
8	Installation	21
8.1	D-POS II Connections	21
8.2	Mounting options	22
8.3	Antenna installation	22
8.3.1	Ferrite antenna	22
8.3.2	Loop antenna	24
8.3.3	Synchronization	24
9	Applications	25
9.1	Overview	25
9.2	Wandering alarm	25
9.3	Surveillance of doors in a corridor	25
9.4	Alarm with positioning	25
9.5	Door opening	25
9.5.1	Example: Exiting a door by pressing a PUSH	26
	Appendix A Technical data	27
	Appendix A.1 D-POS Parts	27
	Appendix A.2 D-POS II Unit	27
	Appendix A.3 Approved AC/DC adaptors	28
	Appendix A.4 D-POS ANT (Ferrite antenna)	28
	Appendix A.5 Loop antenna	28
	Appendix A.6 SMILE ID	28

1 Introduction

1.1 Intended use

The D-POS II system is a versatile and highly customizable system for monitoring and surveillance of wardens, users, zones, doors, stairs etc. in order to create a safe, flexible and easily manageable environment for the dementia care sector.

1.2 General

This technical handbook is intended for service personnell, advanced administrators and other persons involved in setting up, customizing and maintaining the system.

A common denomination for the system is **D-POS II** and where used it relates to the system as a whole. When necessary the specified units are mentioned by their part name (see below).

Alarms and alerts can be transmitted to either the portable tranceiver D-TREX 2G and/or used in a D-SERVER system environment.

For more information about the D-TREX and D-SERVER, please contact your distributor.

1.3 This handbook

Information notes and warnings intended for maintenance personnel and/or users are emphasized in these instructions by the pictogram's defined here.



The Information sign and corresponding text is intended for information which might be useful, but not critical for the reader and/or user.



The Warning triangle sign and corresponding text is intended for critical information to which the user and/or reader should pay special attention.

In the running text certain text is **Highlighted** to emphasize terms etc..

More general information can be found in the D-POS II User Manual and SMILE User Manual.

1.3.1 Declaration of conformity

When the device is used it complies to essential requirements and relevant provisions. A complete Declaration of Conformity can be obtained from the internet address:

www.neat-group.com/downloads/documentation

2 **Important**

2.1 **Safety notes**

- Read instructions prior to use.
- Always test the system per instructions prior to use.
- The product may not be suitable for all persons.
- Check device regularly and replace when necessary.
- Always check the function of the product after making adjustments.
- Our units are NOT intended for any life support device, thus intending a device whose malfunction may result in damage to a life.

2.2 **Use**

- Use only original parts.
- Do not expose to direct sunlight.
- Keep away from dust, moist and dirt.
- Do not drop, knock, twist or shake the device.
- Do not warm up the device or use it near fire.
- The D-POS II may not be painted.
- For repairs, contact a NEAT dealer.

2.3 **Cleaning**

- Clean the device with a soft cloth, dampened slightly with mild soapy water.
- Do not clean the device with harsh chemicals, solvents or other corrosive substances.

2.4 **Recycling**

Dispose of properly. The worn out product must be returned to a recycling facility for proper disposal or returned to NEAT Electronics.

3 Parts in the system

The D-POS II system consist of several parts which all are designed to work together.

3.1 D-POS II unit

This is the central unit in a D-POS system. It is a small unit, easy to mount on a wall or in a junction box and is highly customizable (see D-POS II User Manual, NE41 170028-00). The functions are programmed either by DIP swithes or a computer (this requires a NPU) and the RFID range can be adjusted.



3.2 D-POS Antenna

The D-POS Antenna is a ferrite antenna creating a magnetic field, called zone, which is used to trig the SMILE ID. The zone itself is a passive component in the system but is used to create areas to which access is allowed or prohibited.

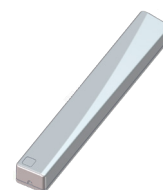

3.3 Loop Antenna

This is actually an electric cable conected to the D-POS II as a loop. This cable can be integrated into door posts or floors making the installation virtually invisible, see "8.3.2 Loop antenna".

3.4 SMILE ID

This is the portable alarm trigger, to be worn either by the caretaker or wardens. The main functions are identical to those of the SMILE with the significant difference that the hardware is adapted to work with the D-POS Antenna and/or LOOP antenna.

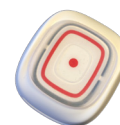

3.5 D-TREX2G

The D-TREX2G is a portable alarm receiver which can receive alarms and display the user and location. It suports RFID and can also indicate Precense/Ready at the user's premises.



3.6 DOOR

DOOR is a small door sensor which can be used to indicate if a door is open or closed, all wirelessly.



3.7 LOOP

Create longer Loop antennas (50 or 100) meters with a LOOP.

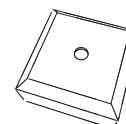

3.8 U-DAT S

U-DAT is a radio transmitter for positioning intended to be used for wandering alarms in home care or in ward facilities with a D-POS Antenna.



4 D-POS II hardware

The D-POS II can be equipped with either a loop- or a ferrite antenna, depending on the application. The loop antenna normally has higher performance but may require a more complex installation. The ferrite antenna has a nice form factor and is easier to install.

4.1 Hardware overview

#	Denomination
1	Rotary switches, S1-S3
2	Potentiometer, P1
3	Connectors, J2 & J4
4	DIP switches, DIP1 - DIP8
5	Radiobutton, B1

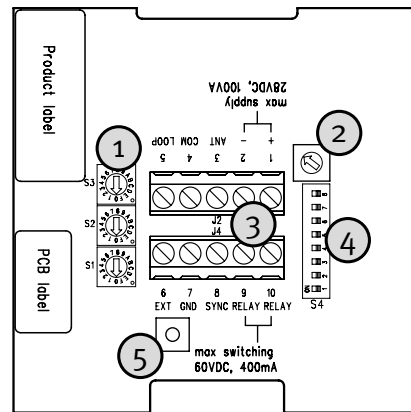
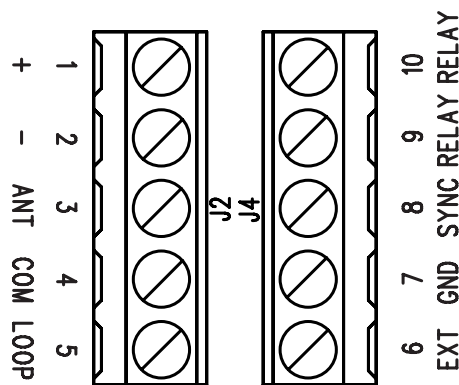

Table 1. D-POS II PCB overview

4.2 Connectors



Picture 1. D-POS II J2 and J4 connectors.

#	Text	Function	
J2	1	+	Source power, 10-28V _{DC}
	2	-	Source power, ground (internally connected to #7)
	3	ANT*	A ferrite antenna should be connected between ANT and COM
	4	COM	Common connection for ferrite/loop antenna
	5	LOOP*	A loop should be connected between LOOP and COM

J4	6	EXT	External activation
	7	GND	Common ground for SYNC and EXT (internally connected to #2)
	8	SYNC	Synchronization of two other D-POS units
	9	RELAY	Galvanic isolated relay output
	10	RELAY	Galvanic isolated relay output

Table 2. The functions of the J2 and J4 connectors

* Either one ferrite OR loop antenna can be connected simultaneously.

4.2.1 Rotary switches (S1 - S3)

The rotary switches S1 - S3 are used to set Position Id codes and the Zone ID, see "5.1.1 Setting position ID and Zone".

4.2.2 Potentiometer (P1)

The potentiometer P1 is used to manually adjust the power range and is within the range set by DIP7, see "5.1.3 RFID range adjustment".

4.2.3 DIP Switches (DIP1 - DIP8)

The DIP switches are used to program the unit and DIP1 must be set to **OFF**.

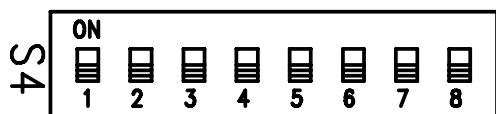

Picture 2. DIP Switches, DIP1 - DIP8

Text	Function	On	Off
DIP1	Configuration	Computer	DIP-switches
DIP2	Not used	N/A	N/A
DIP3	External input mode	Normally closed	Normally open
DIP4	External input function	Antenna	Radio alarm
DIP5	Relay output source	Tamper	Radio received
DIP6	Send radio alarm at tamper	Yes	No
DIP7	Power level	High	Low
DIP8	Walk test mode on/off	Active	Not active

Table 3. DIP Switches functions

4.3 LED

D-POS II has one dual-colour (green/red) LED and during normal operation this is lit green.

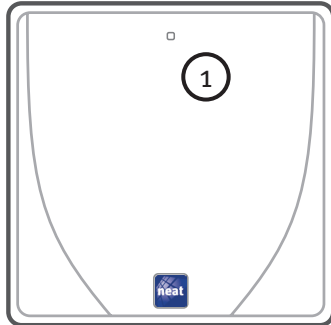

Picture 3. LED on D-POS II (marked with 1)

4.3.1 LED indications and functions

The LED indications are categorized and with different priorities, i.e. the green light (priority 5) is superseded by the red flash (priority 3) if there is an antenna failure. At power on, the LED blinks Yellow (Red+Green) two times 0.1s On/0.1s Off.

LED Colour	Function	Priority
Red	Radio transmission in progress	1 (highest)
Green blink (2.0s on+1.0 off)	Acknowledgment received	2
Red flash (0.5s on/0.5s off)	Tamper or antenna failure*	3
Red	Relay active due to received radio message	4
Green	Normal operation (RFID is emitted)	5
Off	Waiting for external activation	6

Table 4. LED Indications, its functions and priorities.

*This indication is not active if both DIP5 and DIP6 are set to **OFF**.

4.4 Relay

This relay output is closed under normal operation and is opened if any or all of the following occurs:

- The unit loses power
- A tamper alarm is triggered
- There is an antenna failure.

The output is open during boot up which normally takes a second or so, but is closed when the unit has booted up and runs normally.

4.5 Power supply

The D-POS II is powered with 10-28 V_{DC} and this can be either a AC/DC adaptor or a central power supply source. Only use the AC/DC adaptor provided by NEAT, see "Appendix A.3 Approved AC/DC adaptors".

5 D-POS II configuration

D-POS II can be programmed with the onboard DIP switches or with a computer. All functions for a simple setup can be configured with the on-board switches and do not require the programmer. But in large installations programming with computer can save time since configuration templates can be created and only few parameters must be changed for each unit when installing. In reverse, in large installations each D-POS II configuration can be saved in case a particular unit must be replaced.

DIP switch 1 determines whether programming is done via a computer or with the on-board switches (i.e. local programming).

DIP 1 setting	ON	OFF
Programming mode	Computer	Local

Table 5. DIP1 programming setting

5.1 Local programming

Local programming means programming with the on-board DIP-switches, rotary switches and potentiometer. To program with a computer, see chapters 5.2 and 6.

5.1.1 Setting position ID and Zone

Position Id codes (rotary switches S1 and S2)

A unique position Id code is required for each D-POS II to differentiate the units in the system and to be able to locate it. The position Id code is a 4 digit hexadecimal value where the first two digits are set to 00 (ZeroZero). Each D-POS II supports 255 position Id codes and these are set with the rotary switches S1 and S2.

Example: Set S1 to 7 and S2 to B gives the position Id code 007B (ZeroZero7B).



Position code 0000 (ZeroZeroZeroZero) is reserved and forbidden!

Zone ID (rotary switch S3)

The unit must be assigned a Zone ID, a hexadecimal value between 0 (zero) and F, making it possible to configure the receivers to select which zones they shall listen to. This in turn makes it possible to let D-POS II wake-up only specific receivers.

5.1.2 Enter Radio Transmitters

D-POS II can work as a radio receiver and any NEAT radio transmitter can be programmed into the unit. This is done with the button **B1**.

Program a radio transmitter id code

1. Press the button **B1**.
2. After 3 seconds the LED starts flashing red (150ms on/400ms off) every 2 seconds according to below (the number of flashes corresponds to a radio position, e.g. 3 flashes equals radio position 3):
1 flash - 2 flash - 3 flash - 4 flash - 5 flash - 6 flash - 7 flash - 8 flash - 1 flash - ...
3. Release the button **B1** at the desired radio position.
4. Activate the radio transmitter.
5. If the radio code is successfully received, D-POS II flashing green rapidly for 2 seconds whereafter the unit returns to normal mode.

Erase a radio transmitter Id code

Follow steps 1-3 in "5.1.2 Enter Radio Transmitters" above.

After releasing the button **B1** at the desired radio position, press button **B1** for more than 3 seconds. The deletion is indicated by the LED flashing green rapidly for 2 seconds whereafter the unit returns to normal mode.

Send a manual radio alarm

Press button **B1** between 0.1 and 3 seconds to send a manual radio alarm with alarm type 00 (two zeroes). This makes it possible to enter the D-POS II radio code into another radio receiving unit.

5.1.3 RFID range adjustment

The RFID range depends on the output power but also on the orientation of the field in relation to the the antenna coil in the receiver. It is possible to select between two power levels with DIP7 and within each level it is possible to fine tune the power with the potentiometer P1.

Range is low to high when rotating potentiometer P1 clockwise.

The table below show indicative values of range when a ferrite antenna is used.

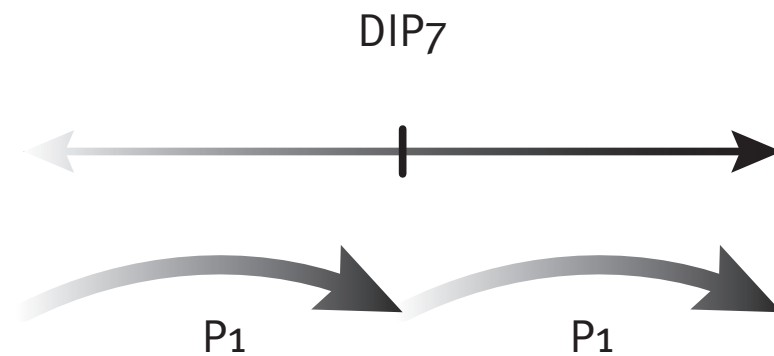

Range	DIP7 = Off	DIP7 = On
Max (180° aligned with field)	0.9 – 1.7 m	1.6 – 3.0 m
Min (90° against field)	0.4 – 0.7 m	0.7 – 1.1 m

Table 6. Indicative RFID ranges with a ferrite antenna

In reality the probability for a minimum range will be very small since the receiver will never appear exactly 90° against a field. Please also note that D-TREX 2G and A-PAGER have two coils mounted 90° against each other which will improve the situation further.

5.1.4 Tamper and malfunction

This is indicated by the LED, see "4.3.1 LED indications and functions".

Tamper

The D-POS II can send an alarm if the housing is opened (tampered with). This works with both 1 mm and 13 mm wall frames.

DIP5 and DIP6 determines what action to take when tampering is detected.

- If DIP5 is **On** the relay output is activated.
- If DIP6 is **On** a radio alarm with alarm type **Tamper** is sent.

Malfunction

When ferrite antenna is used, antenna failure means that the unit detects a short circuit or open circuit. When loop is used, antenna failure means that the unit detects an open circuit.

5.1.5 External input

To avoid that the D-POS II unit emits its RFID continuously it is possible to activate it remotely. A typical situation when the unit would start to emit a field is when a door is opened.

The unit is equipped with a wired external input on the screw terminal #6. DIP3 determines if the input is normally open (DIP3 = Off) or normally closed (DIP3 = On).

If this function is active in configuration and the external input is set to **Antenna** (i.e. DIP4 = On) the unit only emits a field when the external input is active.

DIP4 determines which function the input shall control. It is possible to choose between activation of the RFID or send a radio alarm.

To have no function, set DIP3 to Off (=normally open) and do not connect anything on terminal #6.

5.1.6 Walk test

To verify the size of the RFID field a walk test mode can be activated with DIP8.

When a portable trigger with RFID functionality (e.g. SMILE ID or D-ATOM) is inside the RFID field its LED will flash once per second but will NOT make any transmission.

The color of the LED indicates if the portable trigger is configured to send an alarm when passing an RFID field or not.

LED colour	Function
Red flash	Portable trigger is inside field, alarm will be sent
Green flash	Portable trigger is inside field, alarm will NOT be sent

Table 7. Walk test trigger indication

Activating walk test

1. Set DIP8 to **ON**.
2. Test the coverage by using a SMILE ID (or any other RFID enabled receiver). As long as the LED flashes red or green the SMILE ID is in the RFID field.
3. If the coverage is adequate remove any receiver from the the field and end the walk test mode by setting DIP8 to **OFF**.

If coverage needs adjustment: deactivate the walk test mode, adjust RFID range and repeat steps 1-3 above.

5.2 Programming with computer

Programming with a computer requires a NPU (NEAT Programming unit) and the software WALL Family Programmer v2.1 or later which both can be obtained from your distributor.

Install the NPU and its drivers prior to installing the WALL Family Programmer. If you have trouble installing, please contact your distributor.

The next chapter describes programming with WALL Family Programmer.

6 WALL family programmer

6.1 Select device tab

When WALL Family programmer is started a page with an array of products is displayed. Click on the D-POS II picture to open the RFID, I/O and General info tab.

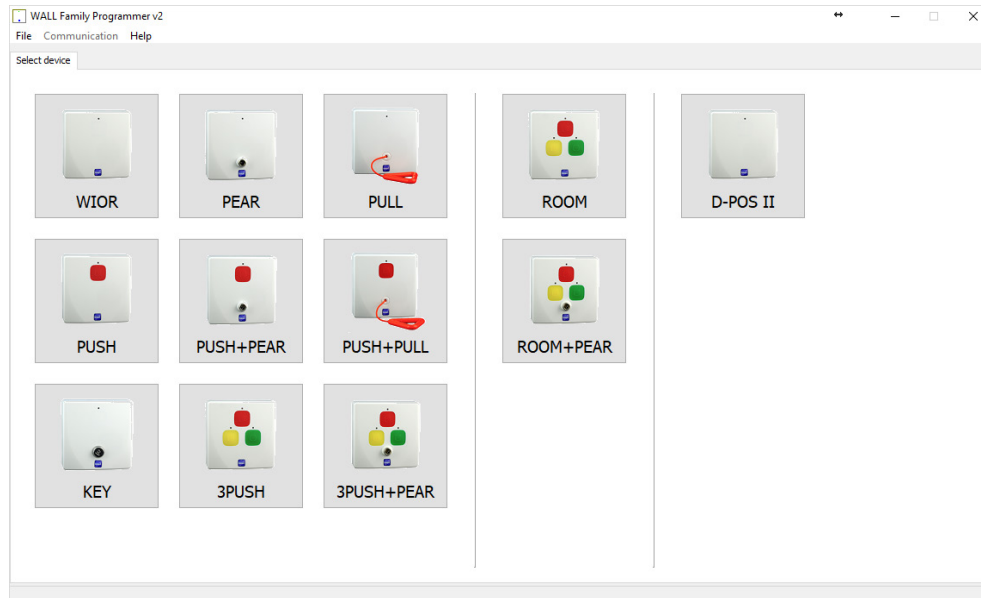

Picture 4. WALL Family Programmer device page

6.2 RFID, I/O and General info tab

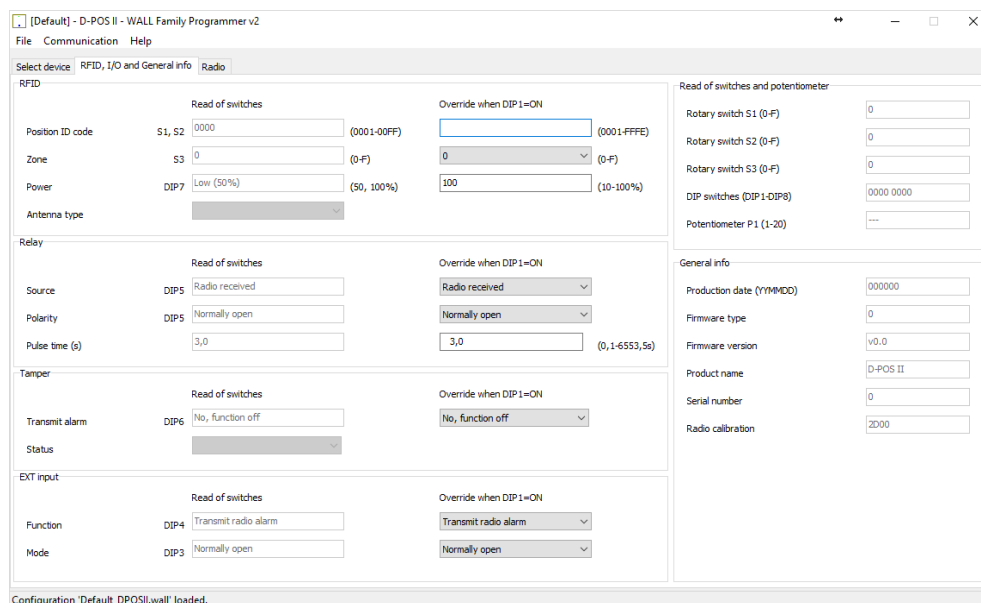

Picture 5. D-POS II - RFID, I/O and General settings

6.2.1 Local programming vs computer programming

The values in the RFID section are displayed in two columns. The values in the left column, "Read of switches" are the values from the potentiometers S1-S3 and DIP2-DIP7. These values are greyed out and can not be edited here, but must be manually changed at the actual switch/DIP, i.e. these values are from the local programming. However, when DIP1 is set to ON all programming is made from a computer and the values in the right column, "Override when DIP1=ON" are editable. The default values and ranges are somewhat different. The picture below displays the two "columns".

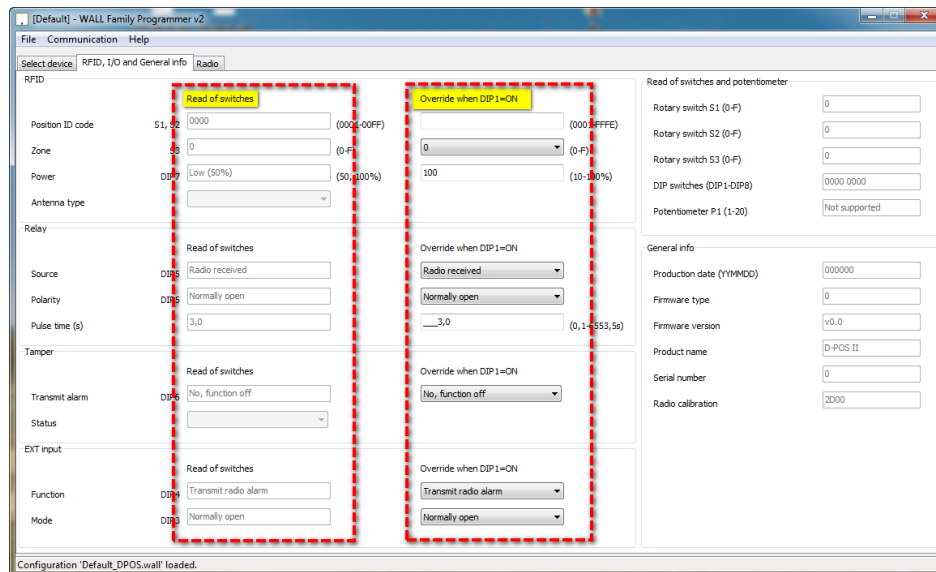

Picture 6. Values of switches and potentiometers

6.2.2 RFID section

Position ID code

It is possible to change the position code that is sent from the antenna. When the ID code is set by switches the value range is between 0001 to 00FF and when set by computer the range is between 0001 to FFFE. The value consist of hexadecimal 4 digits.

Zone

The D-POS always sends a zone number together with the position code. By configuring every portable trigger (e.g. SMILE-ID or D-ATOM) which zones it will react on it is possible to create zones where the user is allowed to pass or not. E.g. allowing certain users to access the garden or not. There are 16 zones to choose from, 0 (zero) to F.

Default = 0 (zero)

Power

Local programming

The antenna power range can be adjusted and this is done by setting DIP7 to **On** (high power) or **OFF** (low power) in combination with the rotary switch S3 where clockwork rotation of the switch increases power.

Default value = 50%

Computer programming

Value range: 10-100%

Default value = 100%

Antenna type

The connected antenna type is displayed and can be either of:

- D-POS ANT (ferrite antenna)
- LOOP (cable antenna)
- Unknown (no antenna connected)

6.2.3 Relay

This relay output is closed under normal operation and is opened if one or more of the following occurs:

- The unit loses power.
- A tamper alarm is triggered.
- There is an antenna failure.

The relay output is open during boot up, which normally takes approx. 1 second and is closed when the unit has booted up and runs normally.

Polarity

Default value = Normally open

Pulse time (s)

Default value = 3.0 seconds

6.2.4 Tamper

The unit is equipped with a tamper switch to alert if the unit is opened. DIP5 and DIP6 determines what happens when a tamper is detected. If DIP5 is **ON** the relay output will be activated. If DIP6 is **ON** a radio alarm with alarm type tamper is sent.

Transmit alarm

Default value = Transmit radio alarm

Status

Here the current tamper status is displayed. Statuses can be:

- Not tampered.
- Tampered.
- "" i.e. the D-POS II unit does not support displaying the current tamper status.

6.2.5 EXT input

Function

Default value = Transmit radio alarm

Mode

Default value = Normally open

6.2.6 Read of switches

All these values are read-only and only for supplying info to the user.

6.2.7 General info

All these values are read-only and only for supplying info to the user.

6.3 Radio tab

Picture 7. Radio tab

6.3.1 Radio receiver

This section displays the values for radio reception.

ID code 1-8

These are the radio id codes of the attached radio devices.

Send acknowledge (ACK)

Determine whether the unit sends acknowledges when radio messages are received.
Default = Yes, function on.

D-SERVER system ID

Enter the D-SERVER system ID where the D-POS II unit is used.



Entering 0 (zero) means the D-POS II unit is not used in a D-SERVER system.

Group activation code

Enter the

Value range:

Default = 0 (zero)

Receive frequency band

Set the reception frequency for the unit.

Default = 869.2 MHz

6.3.2 Radio transmitter

This section determines values for radio transmission.

Unit ID code

The Unit ID code is used as the Radio ID code for radio receivers.

Max number of short transmissions

Enter the max number of short transmissions. Default = 3.

Max number of long transmissions

Enter the max number of long transmissions. Default = 3.

Max number of bursts

Enter the max number of bursts. Default = 1.

Time between bursts (s)

Enter the desired time between bursts. Default = 3

Ignore received acknowledge

Determine whether the D-POS II unit should ignore received acknowledge from other radio transmitters. Default = No, function off (i.e. acknowledge is NOT ignored).

Radio test alarm interval (minutes)(o=off)

Set the interval for radio test alarms. Default = 0 (zero)

Transmit frequency band

Select which frequency band the unit should send in. Default = 869.2 MHz.

6.3.3 Alarm types

This section determines what alarm type to be sent when certain events occur. E.g. in this example when the tamper switch is activated the D-POS II units sends a Tamper alarm.

The default alarm types for events are:

Event	Alarm type
Button	No alarm type
Tamper	Tamper alarm
Antenna failure	Technical failure
EXT input	Door alarm
Radio test	Radio test alarm

Table 8. Default alarm types

6.3.4 Plug-n-play

This is the equipment type. Default = 24.

7 Portable trigger SMILE ID

7.1 Unit appearance

The portable trigger SMILE-ID can be worn either as a watch or as a necklace. It has all the main features in a standard SMILE, with the addition of a RFID receiver that enables the unit to work with D-POS Antennas and loop antennas, whereas the SMILE does not.

Basically, the RFID receiver is triggered when the SMILE ID enters the magnetic field of the antenna and depending on configuration, it acts or not.



Picture 8. SMILE ID front with wristband

8 Installation

It is recommended to install the antenna (either a loop or a ferrite antenna) as well as preparing the necessary cabling for power, sync relays etc. prior to installing the D-POS II unit.

Below is a recommended path when installing a D-POS II.

- Make the configurations and test the settings prior to installing (preferably on a table).
- Prepare the site where to install by installing the antenna, power supply, sync cables etc..
- Mount the D-POS II.
- Connect the antennas, relays, external inputs, sync etc..
- Connect power to the unit.
- Run and test.
- Adjust RFID field if necessary.

8.1 D-POS II Connections

The picture below displays how and what to connect to the screw terminal in the D-POS II control unit.

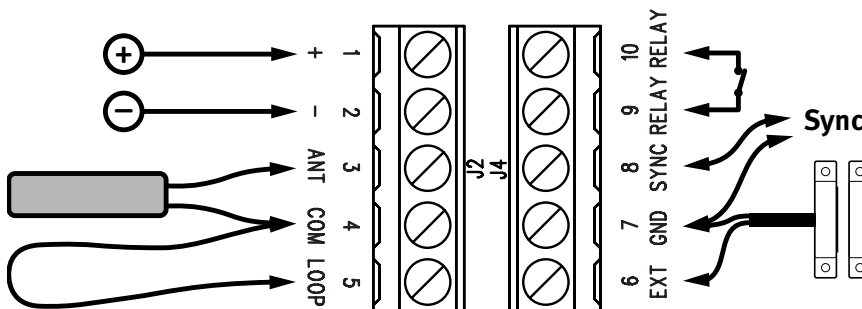

Picture 9. Screw terminal in the control unit and connected parts

#	Text	Function	
J2	1	+	Source power 10-28V _{DC}
	2	-	Source power Ground
	3	ANT*	A ferrite antenna should be connected between ANT and COM
	4	COM	Common connection for ferrite/loop antenna
	5	LOOP*	A loop should be connected between LOOP and COM
J4	6	EXT	External activation
	7	GND	Common ground for SYNC and EXT (internally connected to #2)
	8	SYNC	Synchronization of two other D-POS units
	9	RELAY	Galvanic isolated relay output
	10	RELAY	Galvanic isolated relay output

Table 9. Screw terminal connections

* Either a ferrite OR a Loop antenna can be connected!

8.2 Mounting options

D-POS II is designed to be installed either on a wall (with a 13 mm mounting socket) or in a junction box with cc 60 mm using the 1 mm mounting socket.

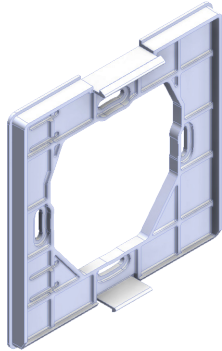

Picture 10. 1 mm mounting frame

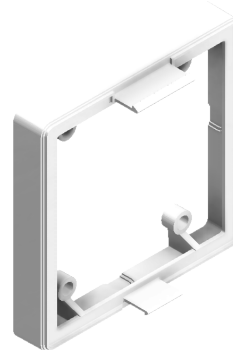

Picture 11. 13 mm mounting frame

8.3 Antenna installation

The unit can be used with either loop or ferrite antenna and this is automatically detected by D-POS II.

8.3.1 Ferrite antenna

D-POS Antenna is a ferrite antenna specially designed to create a low frequency magnetic field with a coverage suitable for doors and passages in wardens and/or homes.

When placed horizontally the emblem should be visible to the left and when placed vertically it should be visible at the bottom.



Picture 12. Outline of the ferrite antenna



The ferrite rod inside the cover is made of carbon and is fragile. Please handle with special care and do not drop, knock or twist the unit.

Inside the ferrite antenna

Open the antenna cover by unscrewing the cover screw at the bottom (near the emblem). Inside there are three cable outlet holes for the cable and a screw terminal.

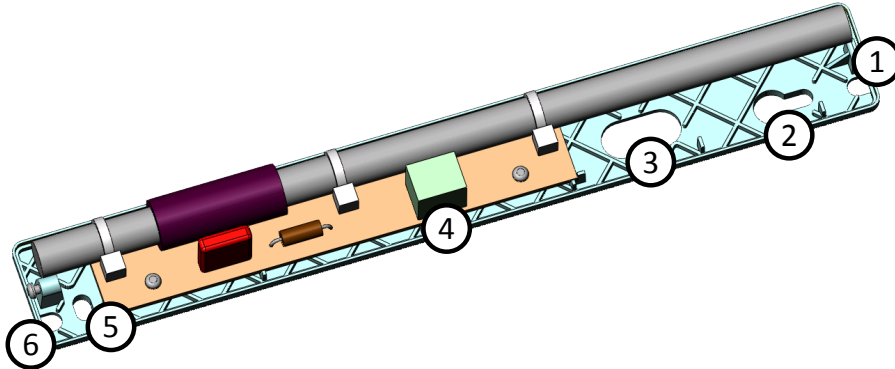

Picture 13. Interior of the ferrite antenna.

#	Denomination
1	Cable outlet
2	Keyhole (for wallmounting)
3	Cable outlet
4	Screw terminal
5	Screw hole (for wallmounting)
6	Cable outlet

Table 10. D-POS Antenna bottom case denominations.

Ferrite antenna installation

Follow the steps below for best mounting of the antenna.

1. Remove the cover.
2. Decide what cable outlet hole (#1, #3 or #6) that is most appropriate to use.
3. Mark where to put the upper screw and screw it into the wall.
4. Hang the cover in the key hole and mark where to put the lower screw.
5. Put the cable through the outlet and connect the wires to the terminals.
6. Place the cover on the wall and attach both screws.
7. Hang the front cover on the upper plastic stop and close the cover by fasten the bottom cover screw.

If one ferrite antenna is used the field range will vary depending on the orientation of the SMILE ID. If there is a problem with sensitivity and/or activation it is possible to use two antennas with different orientation, like in the picture below.

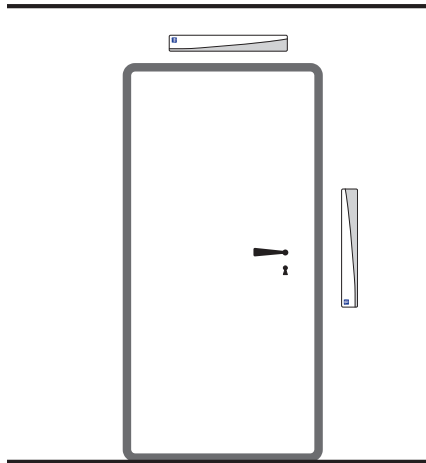

Picture 14. *Placing two ferrite antennas on a door*

8.3.2 Loop antenna

The loop antenna is a cable installed around a door, on the floor or in the ceiling. If the area of the loop increases the field also increases. Below are two examples how to install the loop antenna. Occasionally it is desirable to hide the control unit for instance above the inner ceiling. If so, twist the cable all the way from the loop's beginning to the control unit. Twisting the cable diminishes the magnetic field to a minimum in the twisted part.

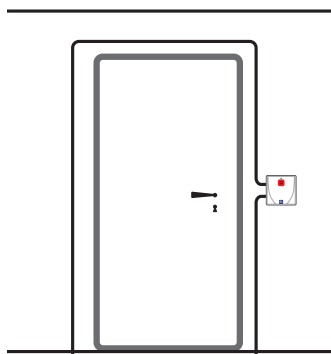

Picture 15. *Loop antenna around a door frame*

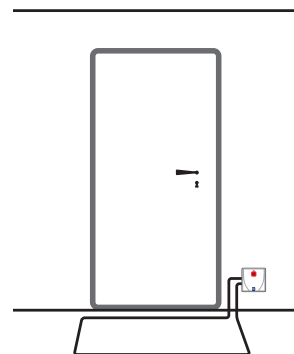

Picture 16. *Loop antenna on the floor*



The entire length of the loop antenna cable must not exceed 10 meters.

The loop antenna can be extended to 50 or 100 meters with the article LOOP.

8.3.3 Synchronization

It is possible to synchronize up to three D-POS units in order to avoid that they interfere with each other. This is done by connecting GND (screw terminal 7) and SYNC (screw terminal 8) on one unit to the corresponding screw terminals on the other unit.

It is possible to synchronize both D-POS and D-POS II units.

9 Applications

9.1 Overview

The main feature of the D-POS II system is the low frequency field (LF field) and the SMILE ID. When a person wearing a SMILE ID enters the LF field, a signal can be sent from the SMILE ID to an alarm receiver. The alarm receiver can be a portable receiver (D-TREX2G), a home care phone (NOVO) or any other receiver from NEAT Electronics (e.g. WIOR).

Below are some conceptual examples of use.

9.2 Wandering alarm

By using zones it is possible to give persons various permissions in a building.

A basic application is to use the D-POS II/SMILE ID system as a monitoring tool of caretakers movements in the premises. If a person with a SMILE ID passes a doorpost with a D-POS Antenna or loop antenna, the SMILE ID will send an alarm to an alarm receiver with possibility to include the position and user information. It is possible to create zones, so that some persons are allowed to pass some doors but not others.

9.3 Surveillance of doors in a corridor

In a case with many rooms (e.g. a corridor) and when it is only required to monitor the movements of persons, the zone solution is not suitable.

Here it is recommended to use a D-POS II for each room/door, assign a unique code for each D-POS II and NOT use zones.

9.4 Alarm with positioning

With several D-POS II in a building it is possible to create zones. The SMILE ID can be configured to just store the latest passed position (without sending any information at that time). When a person is in need and presses the alarm button, the SMILE ID sends the alarm and include the latest position. The position is then showed in the portable alarm receiver D-TREX2G.

9.5 Door opening

Another application is to use the system to control and manage equipment when a person approaches a door. E.g. the SMILE ID can send a signal to a D-POS II which will activate a relay output. The relay can be connected to an automatic door opener or a door lock. It is of course also possible to lock the door when the person is nearby.

9.5.1 Example: Exiting a door by pressing a PUSH

In this example the situation is quite straightforward: in a residential home a door needs to be monitored from a reception or similar.

Prerequisites:

- A D-POS II and a D-POS Antenna are mounted on a door post. A PUSH is mounted next to the door post or in the vicinity.
- The door is equipped with a door lock mechanism.
- The door must be locked at all times but there must be the possibility to open without a key.
- There is only one caregiver and one caretaker.
- Caregiver and caretaker wears SMILE IDs.
- The door unlocks automatically for the caregiver and the caretaker must press the PUSH for it to unlock.
- When a care taker presses the PUSH button a lamp in the reception is lit to indicate that the care taker is approaching and has pushed the red button.

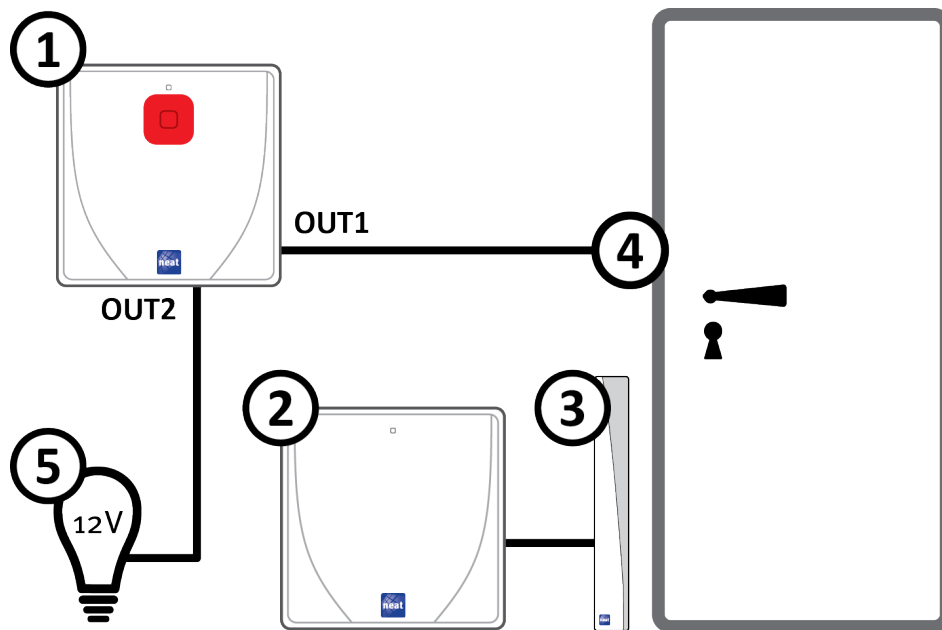

Picture 17. Door opening with D-POS II, D-POS ANTENNA and a PUSH unit

#	Denomination
1	PUSH unit
2	D-POS II unit
3	D-POS Antenna
4	Door lock mechanism
5	Light indication

Table 11. Hardware used in the setup

Appendix A Technical data

Appendix A.1 D-POS Parts

These are the article numbers for standard products. Deviations may occur for customized kits and/or customers.

Denomination	Article number
D-POS II Kit, Standard	NE10 17003-01
Mounting frame, 1 mm	NE32 11003-04
Mounting frame, 13 mm	NE32 11003-05

Appendix A.2 D-POS II Unit

Denomination	Data
Dimensions (W x H x D)	86 x 86 x 26 mm
Weight	85 g
Supply voltage	12-28 V _{DC} , 1,6 A (See table Table 13 for approved AC/DC adaptors.)
Current consumption	Standby = 25 mA, Max = 1,5 A
Frequency _{RF} - EU	869.2 MHz, Social alarms
Frequency _{RF} - Non EU*	866.2, 868.2, 906.2, 916.2 MHz

* According local regulations for social alarms

Door codes	≤65000
RFID power steps	32
Loop resistance _{max}	1 kΩ
Working temp	5-35 °C

Output #9, #10

Resistance _{max} (Closed)	2 Ω
Blocking voltage _{max}	60 V _{DC}
Load current _{max}	400 mA
Leakage current _{max} (Open)	1 μA
Isolation voltage	1500 V _{DC}

Table 12. D-POS II technical data

Appendix A.3 Approved AC/DC adaptors

Region	Article number
EU (except UK)	NE31 17003-01
UK	NE31 17003-02

Table 13. Approved AC adaptors for different regions

Appendix A.4 D-POS ANT (Ferrite antenna)

Dimensions (W x H x D), mm	213 x 23 x 29 mm
Weight, g	130 g
Working temp	5-55 °C

Table 14. D-POS ANT technical data

Appendix A.5 Loop antenna

Maximum cable length	10 m
Cable area	0.4 (AWG 21) mm ²

Table 15. LOOP antenna technical data

Appendix A.6 SMILE ID

Dimensions (W x H x D)	35 x 44 x 11 mm
Weight	13 g (excl. accessories)
Battery nominal voltage	3 V _{DC}
Battery type	Lithium CR2430
Battery life	5 years
Frequency _{RF} - EU	869.2 MHz (social alarms)
Frequency _{RF} - Non EU*	866.2, 868.2, 906.2, 916.2 MHz

Bandwidth	25 kHz
Transmission range	>100 m in free air
Battery alarm	Yes
Power save mode	Yes
Working temperature	5-55 °C

Table 16. SMILE ID technical data

This page is intentionally left blank.

www.neat-group.com